

ExSite® Enhanced 2 Explosionproof Fixed Camera System

Product Features

- Up to 1920 x 1080p Resolution Wide Dynamic Range (WDR)
- Multi-Stream H.264 and H.265 IP Video with Smart Compression
- Rated to Operate from -50 °C to +60 °C (-58 °F to 140 °F), with ambient convection
- AISI 316L Stainless Steel Electro Polished Construction
- Standard IP Ethernet Connection
- Full Suite of Built-In Analytics
- Electronic Image Stabilization
- Onvif Profiles S, G, and T Conformant
- Certifications: FCC Part 15, CE, UL/cUL, ICES-003, RCM, BIS
- Hazardous Location Certifications: IECEx, ATEX, INMETRO, EAC Ex, UL/cUL



Camera System

ExSite® Enhanced 2 Series is purpose-built to monitor operations and control processes in hazardous locations with risks of explosion due to the presence of flammable liquids, gases or dust. Rugged outdoor cameras available in fixed, fixed compact, and PTZ, it meets stringent explosion proof and dust-ignition proof requirements while complying with international standards (UL, CSA, ATEX, IECEx, EACEx).

It provides to operators crisp and clear evidence with 30X optical zoom, with true WDR, and low light capabilities for challenging lighting conditions common to hazardous areas. The ExSite® Enhanced 2 Series is built to survive in the harshest conditions, rated IP69 it protects from water, high wind, high and low temperatures with an operating range of -50°to +60°C. It is also resistant to corrosive elements.

ExSite® Enhanced 2 Series cameras are easy to install and adaptable to most operational needs. ExSite® Enhanced 2 Series cameras support a range of input power options. ExSite® Enhanced 2 Series cameras also come standard with wipers and sun shrouds, capturing desired video regardless of the weather.

The ExSite® Enhanced 2 Series provides industry-leading image quality using a Full HD 1080p camera producing up to 60 images per second. The camera's image defog capability increases video quality in poor visibility conditions and 3D noise filtering is available.

Video

ExSite® Enhanced 2 Series cameras provide flexible streaming options. The primary stream can be compressed with efficient H.265, H.264 High or Main profiles, or MJPEG formats. It can be configured to a variety of frame rates and variable bit rates to optimize image quality with bandwidth and storage

efficiency. Smart Compression is available on both H.264 and H.265, minimizing storage and bandwidth utilization.

Open and Integrated

ExSite® Enhanced 2 Series cameras seamlessly connect to Pelco video management systems such as VideoXpert®. ExSite® Enhanced 2 Series cameras integrate with major third-party systems through the ONVIF Profile S, Profile G, and Profile T standards.

Standard Web Interface

Pelco cameras use a standard Web browser interface for easy remote setup and administration. Controls are optimized for convenient one-step camera configuration for features including color, exposure, flicker control, backlight compensation, and streaming.

Pelco Analytics

ExSite® Enhanced 2 Series cameras feature Pelco's most advanced analytics technology.

Basic Analytics

ExSite® Enhanced 2 Series cameras feature basic video analytics including Simple Motion Detection and Camera Sabotage.

Simple Motion Detection: These algorithms allow the camera to record or send an alarm when there is motion detected in a selected zone or with the entire scene.

Camera Sabotage: An alarm is triggered if the lens is obstructed or when the camera is repositioned.

Pelco Smart Analytics

Pelco Smart Analytics uses object detection AI technologies delivering improved accuracy in both perimeter protection and in crowded, indoor environments. Added processing power enables the tracking and classification of over 50 objects. Objects are classified even when they remain stationary. Pelco Smart Analytics go beyond people and vehicles to include car, truck, bus, motorcycle, and bicycle classification. Ten different object behaviors can be recognized to create events integrated with many VMS systems.

Objects Detected	Behavior Events	
People	Objects in Area	Objects Enter Area
Vehicles with Classification	Object Loitering	Objects Leave Area
	Objects Crossing Beam	Object Stops in Area
	Object Appears or Enters Area	Direction Violated
	Object Not Present in Area	

Objects in Area: The event is triggered when the selected object type moves into the region of interest.

Object Loitering: The event is triggered when the selected object type moves into the region of interest and then stays for an extended amount of time.

Objects Crossing Beam: The event is triggered when the specified number of objects have crossed the directional beam that is configured over the camera's field of view. The beam can be unidirectional or bidirectional.

Object Appears or Enters Area: The event is triggered by each object that enters the region of interest. This event can be used to count objects.

Object Not Present in Area: The event is triggered when no objects are present in the region of interest.

Objects Enter Area: The event is triggered when the specified number of objects have entered the region of interest.

Objects Leave Area: The event is triggered when the specified number of objects have left the region of interest.

Object Stops in Area: The event is triggered when an object moves into a region of interest and then stops moving for the specified threshold time.

Direction Violated: The event is triggered when an object moves in the prohibited direction of travel.

Pelco's Smart Compression Technology

Pelco's Smart Compression Technology lowers bandwidth and storage requirements by up to 70%, while reducing storage requirements. Our technology allows the user to make informed optimization between storage savings and image quality.

Pelco's Smart Compression Technology dynamically analyzes motion occurring within live video in real-time, to intelligently compress the information you don't need, while retaining details with clear quality in the areas that are important in the scene.

Technical Specifications

Camera/Optics

Item	Description
Resolution	2.0 MP
Sensor Type	1/2.8" progressive scan CMOS
Maximum Resolution (H x V) and Aspect Ratio	(16:9) 1920 × 1080
Dynamic Range	
WDR Off	83 dB
WDR On	Up to 120 dB
Active Noise Filtering	3D Noise Filtering
Lens	F1.6, 4.3-129 mm (30x zoom) remote focus and zoom
Horizontal Angle of View	(16:9) 3.1°-64°
Vertical Angle of View	(16:9) 1.7°-38°

Item	Description
Light Sensitivity	Color (33 ms); 0.1 lux Mono (33 ms); 0.03 lux
Iris Control	P-Iris, Automatic, Open, Closed
Shutter Range	Automatic, Manual (1/1 to 1/30,000 sec)
Day/Night Capabilities	Mechanical IR cut filter. Automatic, Manual
Flicker Correction	60 Hz, 50 Hz
White Balance	Automatic, Manual
Backlight Compensation	On/Off

Video

Item	Description
Frame Rate	60 fps
Video Encoding	H.264, H.265 Pelco Smart Compression, Motion JPEG
Video Streams	Multi-stream H.264, Multi-stream H.265, Motion JPEG

Software Features

Item	Description
Smart Compression Technology	Yes, lowers bandwidth and storage requirements by up to 70%.
On Screen Displays	Yes
Privacy Zones	Up to 64 zones
Presets	500 named presets
Tours	10 named tours
Digital Defog	Adjustable/Off

Network

Item	Description
Open API	ONVIF compliance version 1.02, 2.00, Profile S, Profile G, and Profile T (www.onvif.org)
Security	Password protection, HTTPS encryption, digest authentication, WS authentication, user access log, 802.1x port based authentication
Supported Protocols	IPv6, IPv4, HTTP, HTTPS, SOAP, DNS, NTP, RTSP, RTCP, RTP, TCP, UDP, IGMP, ICMP, DHCP, Zeroconf, ARP, SNMP v2c, SNMP v3

Mechanical

Item	Description
Dimensions (LxWxH)	0155.5 mm × 264 mm; 06.12" × 10.4" (dimensions without sunshield)
Weight	With 4m cable: 8.5 kg; 18.7 lbs., with 10m cable: 12.0 kg; 26.5 lbs.
Construction	AISI 316L stainless steel
Finish	Electro-polished surface
Wiper	Yes
Cable Entry	3/4" NPT
Cable Gland	Ex db and tb 3/4" NPT and preinstalled armored cable or with tail cable
Armored Cable Option	External diameter: 20.00 mm (0.79") ± 0.50 mm (0.20") Diameter under armature: 15.20 mm (0.60") Color: black RAL 9005 Composition: 3 × 2.5 mm ² (13 AWG), 7 × 0.34 mm ² (22 AWG), 4 × 2 × 0.22 mm ² (24 AWG) (cat. 5E)
Cable Tail Option	3 × 2.5 mm ² (13 AWG), external diameter 8.7 mm (0.34") 7 × 0.34 mm ² (22 AWG), external diameter 6.4 mm (0.25") 4 × 2 × 0.21 mm ² (24 AWG) (cat. 5E), external diameter 6.7 mm (0.26")

Electrical

Item	Description
Local Storage	Micro SD, SDHC, SDXC Compatible
Ports	100BASE-TX, RJ45 Connector (CAT5E cabling)
Power Consumption	53 W
Input Voltage (Power)	VDC: 12 V ± 5% (3.5A), VDC: 24 V ± 5% (2.2A), VAC: 24 V ± 10% (2.2A) at 50/60 Hz
Alarm Inputs	1
Relay Outputs	1 (1A, 30 VAC/60 VDC max)

Environmental

Item	Description
Operating Temperature	-50 °C to +60 °C (-58 °F to 140 °F)
Storage Temperature	-40 °C to +55 °C (-40 °F to 131 °F)

Item	Description
Humidity	10% - 95% non-condensing
Cold Start	Up to 2 hour startup delay at temperature lower than -10 °C (14 °F)

Dimensions

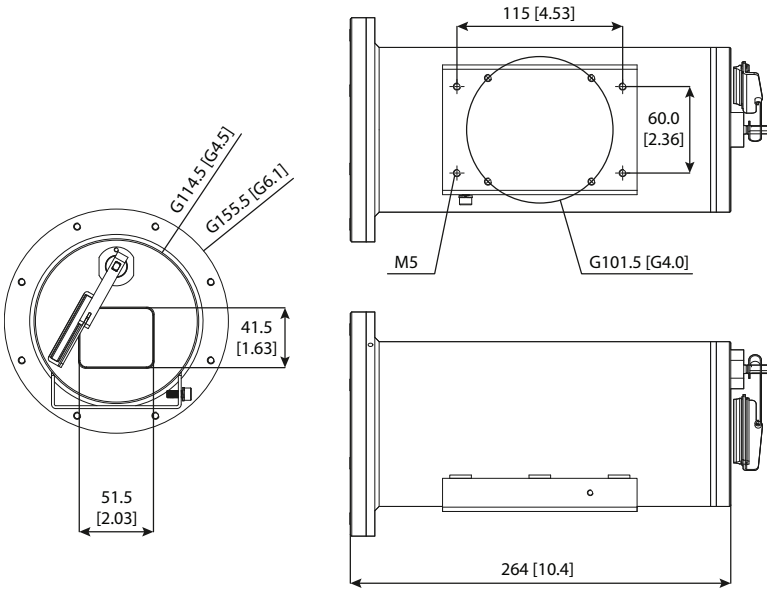

 **Note:** Values in parentheses are inches; all others are millimeters.

System Model Numbers

System Resolution	Model #	Description
2 MP 30X	EXF2230-52-A4	ExSite® Enhanced 2 Fixed, 2 MP x 30, 4m armored Cable w/ gland, T5
2 MP 30X	EXF2230-62-A4	ExSite® Enhanced 2 Fixed, 2 MP x 30, 4m armored Cable w/ gland, T6
2 MP 30X	EXF2230-52-A0	ExSite® Enhanced 2 Fixed, 2 MP x 30, 10m armored Cable w/ gland, T5
2 MP 30X	EXF2230-62-A0	ExSite® Enhanced 2 Fixed, 2 MP x 30, 10m armored Cable w/ gland, T6
2 MP 30X	EXF2230-52-C4	ExSite® Enhanced 2 Fixed, 2 MP x 30, 4m Cable tail, T5
2 MP 30X	EXF2230-62-C4	ExSite® Enhanced 2 Fixed, 2 MP x 30, 4m Cable tail, T6

System Resolution	Model #	Description
2 MP 30X	EXF2230-52-C0	ExSite® Enhanced 2 Fixed, 2 MP x 30, 10m Cable tail, T5
2 MP 30X	EXF2230-62-C0	ExSite® Enhanced 2 Fixed, 2 MP x 30, 10m Cable tail, T6

Mounting Accessories

PEX-NXWBS1



Wall bracket for use with EXF2230 cameras. AISI 316L stainless steel.

PEX-MHXWFWCA



Parapet mounting bracket for use with EXF2230 cameras. AISI 316L stainless steel.

PEX-NXFWBT



Vertical riser, 124 mm (4.9”), for use with EXF2230 cameras. AISI 316L stainless steel.

PEX-NXWTU



Wall adapter module, for use with PEX-NXWBS1. AISI 316L stainless steel.

PEX-NXCOL



Pole mount adapter for use with EXF2230 cameras or explosion protected washers. For pole diameters from 110 mm (4.3”) to 150 mm (5.9”).

Max load 50 kg (110 lb.).

AISI 316L stainless steel.

PEX-NXCW









Corner mount adapter for use with EXF2230 cameras or explosion protected washers. Max load 50 kg (110 lb.).

AISI 316L stainless steel.

Explosion-Proof Communication Box

Communication boxes include a 3-port RJ45 and 1 SFP port Ethernet switch and 24 VAC output for powering up to:

- 2x EXF2230 fixed cameras with 2x washer pump
- 1x EXP2230 PTZ camera with 1x washer pump

PEX-MBA1S5A		Aluminum housing, 230 VAC input.
PEX-MBA2S5A		Aluminum housing, 24 VAC input.
PEX-MBA3S5A		Aluminum housing, 120 VAC input.
PEX-MBX1MAA		AISI 316L stainless steel housing, 230 VAC input.
PEX-MBX2MAA		AISI 316L stainless steel housing, 24 VAC input.
PEX-MBX3MAA		AISI 316L stainless steel housing, 120 VAC input.
PEX-MBXMP		Adapter plate for communication box to PEX-MPXCOL or PEX-MPXCW mounts. AISI 316L stainless steel housing.
PEX-MBXWRE		Wrench for opening communication boxes, PEX-MBX.
PEX-MPXCOL		Pole mount adapter for use with PEX-MBXMP or EXP2230 cameras. For pole diameters from 110 mm (4.3") to 150 mm (5.9").
		Max load 50 kg (110 lb.). AISI 316L stainless steel.
PEX-MPXCW		Corner mount adapter for use with PEX-MBXMP or EXP2230 cameras. Max load 50 kg (110 lb.). AISI 316L stainless steel.

Explosion-Proof Washer

A 10L (2.6 gal) tank with integrated manual pump and delivery up to 20m (66 ft), 24 VAC/VDC input.

PEX-WASEX2T4AT		ATEX certified solenoid valve.
PEX-WASEX2T4IN		INMETRO certified solenoid valve.
PEX-WASEX2T4KC		KCS certified solenoid valve.
PEX-WASEX2T4GOR		EAC Ex certified solenoid valve.





Certifications

Safety and Environmental Certifications

- FCC Part 15
- CE
- UL/cUL Listed
- ICES-003
- RCM
- IP66, IP67, IP68, and IP69 and Type 4X and Type 6P
- BIS certification: IS 13252(PART 1):2010 / IEC 60950-1:2005
- Salt Spray: IEC 60068-2-52
- Camera certified by Videotec S.P.A.: model MVX

Hazardous Certifications

- Tamb -60°C to +55°C (T6 rated models) or +65°C (T5 rated models)
- UL/cUL Hazardous Locations Listed
 - CLASS I, DIVISION 2, GROUPS A, B, C and D, T5
 - CLASS II, DIVISION 2, GROUPS E, F and G, T100°C
 - CLASS I, ZONE 1, AEx db IIC T5 Gb
 - Zone 21 AEx tb IIIC T100°C Db
 - Ex db IIC T5 Gb X
 - Ex tb IIIC T100°C Db X
 - CLASS I, DIVISION 2, GROUPS A, B, C and D, T6
 - CLASS II, DIVISION 2, GROUPS E,F and G, T85°C
 - CLASS I, ZONE 1, AEx db IIC T6 Gb
 - Zone 21 AEx tb IIIC T85°C Db
 - Ex db IIC T6 Gb X
 - Ex tb IIIC T85°C Db X
- IECEx ITS 15.0030X
 - Ex db IIC T5 Gb
 - Ex tb IIIC T100°C Db IP66/IP68
 - Ex db IIC T6 Gb
 - Ex tb IIIC T85°C Db IP66/IP68

- DEMKO 12 ATEX 1031198X
 -  II 2 G Ex db IIC T6...T5 Gb
 -  II 2 D Ex tb IIIC T85°C... T100°C Db
 -  II 2 G Ex db IIC T6 Gb
 -  II 2 D Ex tb IIIC T85°C Db IP66/IP68
- INMETRO UL-BR 16.0004X
 - Ex db IIC T5 Gb X
 - Ex tb IIIC T85°C Db IP66/IP68
 - Ex db IIC T6 Gb
 - Ex tb IIIC T85°C Db IP66/IP68
- Ex
 - Ex db IIC T5 Gb X
 - Ex tb IIIC T100°C Db X
 - Ex db IIC T6 Gb X
 - Ex tb IIIC T85°C Db X

Models and Certifications Matrix

Model	ATEX	IECEX	EAC Ex	INMETRO	KCs	UL/ETL (US & CAN)
EXF2230-52-A4	Yes	Yes	Yes	Yes	—	—
EXF2230-62-A4	Yes	Yes	Yes	Yes	—	—
EXF2230-52-A0	Yes	Yes	Yes	Yes	—	—
EXF2230-62-A0	Yes	Yes	Yes	Yes	—	—
EXF2230-52-C4	Yes	Yes	Yes	Yes	Yes	Yes
EXF2230-62-C4	Yes	Yes	Yes	Yes	Yes	Yes
EXF2230-52-C0	Yes	Yes	Yes	Yes	Yes	Yes
EXF2230-62-C0	Yes	Yes	Yes	Yes	Yes	Yes

Marine Certification

- Lloyd's Register*

*At the time of this publication, certification is pending. Consult the factory or www.pelco.com for the current status of certifications.



Pelco, Inc.
625 W. Alluvial Ave., Fresno, California 93711 United States
(800) 289-9100 Tel
(800) 289-9150 Fax
+1 (559) 292-1981 International Tel
+1 (559) 348-1120 International Fax
www.pelco.com

⚠ WARNING: Cancer and Reproductive Harm -
www.P65Warnings.ca.gov.
⚠ ADVERTENCIA: Cáncer y Daño Reproductivo -
www.P65Warnings.ca.gov.
⚠ AVERTISSEMENT: Cancer et Troubles de
l'appareil reproducteur - www.P65Warnings.ca.gov.

Pelco, the Pelco logo, and other trademarks associated with Pelco products referred to in this publication are trademarks of Pelco, Inc. or its affiliates. ONVIF and the ONVIF logo are trademarks of ONVIF Inc. All other product names and services are the property of their respective companies. Product specifications and availability are subject to change without notice.

© Copyright 2022, Pelco, Inc. All rights reserved.